

GHT



CATÁLOGO DE PEÇAS SISTEMA DE COMBATE À INCÊNDIO

GHT

GRUPO HIDRAUTORQUE



37 anos de mercado

Só uma empresa que respeita o seu cliente e entende o verdadeiro significado de parceria consegue chegar a quase 40 anos de mercado.



Unidades de Norte a Sul do país

O GHT possui 12 unidades estrategicamente espalhadas pelo Brasil para melhor atendê-lo

- 1 Centro de distribuição
- 1 Unidade de serviço
- 1 Matriz Administrativa
- 4 lojas in company
- 1 Unidade fabril
- 4 filiais



430 colaboradores

Profissionais treinados para atender de forma personalizada os mais diferentes segmentos.



Mais de 5.700 clientes atendidos

São cerca de 4.000 consumidores e 1.700 revendas atendidas em todo o Brasil nos segmentos de:

- Construção pesada;
- Ferrovias;
- Mineração;
- Portos;
- Papel celulose;
- Entre outros...



25 mil m² de estoque

O maior estoque de materiais a pronta entrega da América Latina



45 mil itens diferentes em estoque

São mais de 80 mil itens em estoque e mais de 80 linhas diferentes. O GHT destaca-se pela disponibilidade de peças para os mais variados equipamentos.



Mais de 700 despachos diários

Sistema logístico integrado, frota própria e mais de 100 colaboradores atuando na logística, permite o grande volume de despachos diários realizados pelo GHT.



96% de pedidos enviados no mesmo dia

Cerca de 670 pedidos recebidos pelo GHT são despachados no mesmo dia, sendo que mais da metade das operações acontecem após as 16h30.



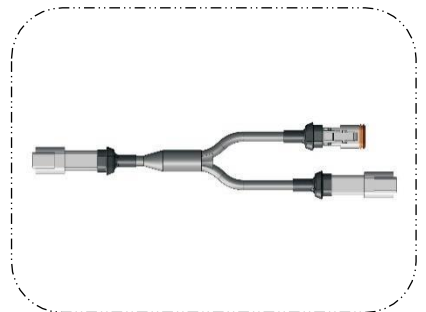
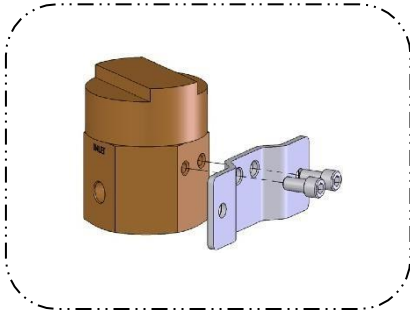
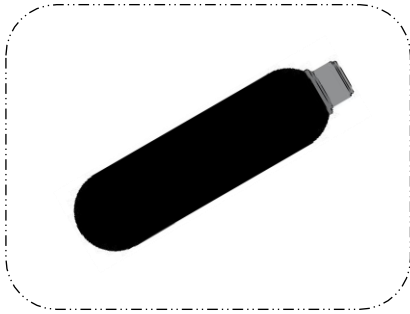
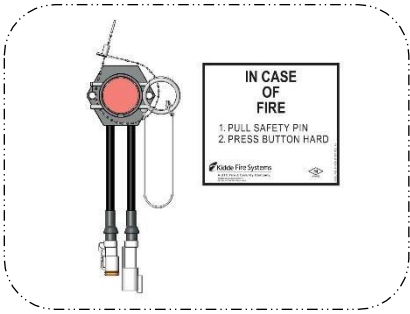
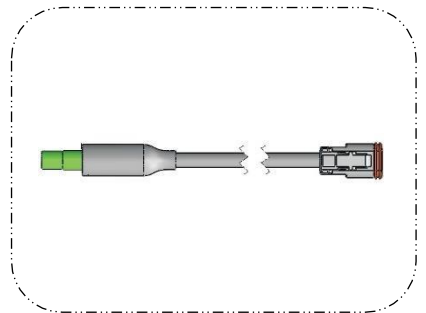
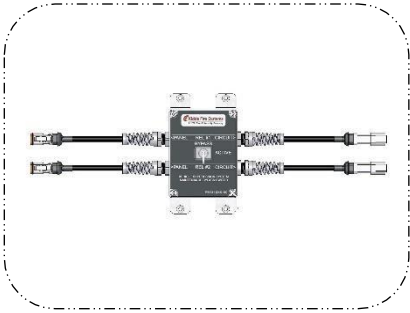
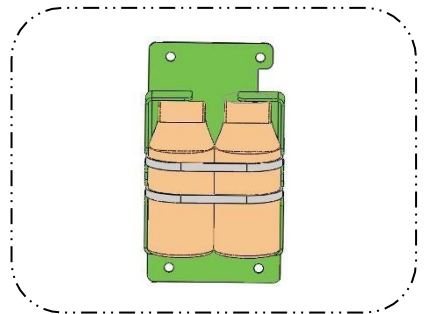



CILINDRO AG . QUÍMICO ABC, DCS-25 (25LB)

PN: 11500-0387

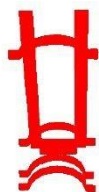

SUPOTE VERTICAL - CILINDRO 25LB

PN: 10231-02



CILINDRO AG . QUÍMICO ABC, DCS-50 (50LB)

PN: 11500-0388



SUPOTE VERTICAL - CILINDRO 50LB

PN: 10180-02



CILINDRO AG . QUÍMICO ABC, DCS-68 (68LB)

PN: PN: 10212-01



CILINDRO AG . LÍQUIDO AQUAGREEN, LS-5 (5 GAL)

PN: 11500-0390



SUPOTE VERTICAL - CILINDRO 5GAL

PN: 11500-0398

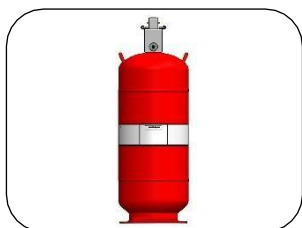

CILINDRO AG . LÍQUIDO AQUAGREEN, LS-10 (10 GAL)

PN: 11500-0391

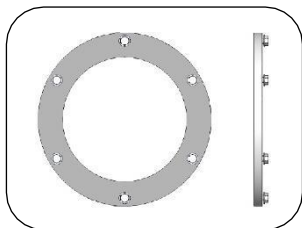

SUPORTE FLANGE PARA CILINDROS, LS-10 / DCS-68 (10 GAL)

PN: 11500-0396

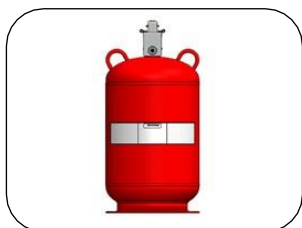

CILINDRO AG . LÍQUIDO AQUAGREEN, LS-15 (15 GAL)

PN: 11500-0392

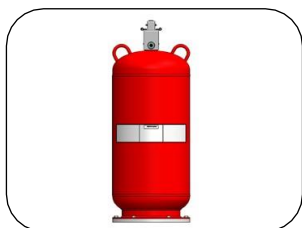

CILINDRO AG . LÍQUIDO AQUAGREEN, LS-20 (20 GAL)

PN: 11500-0393

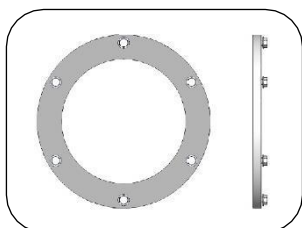

SUPORTE FLANGE PARA CILINDROS LS-15 / LS-20

PN: 10005-12

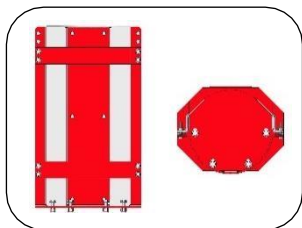

SUPORTE VERTICAL - CILINDRO LS-10 GAL

PN: 11500-0399

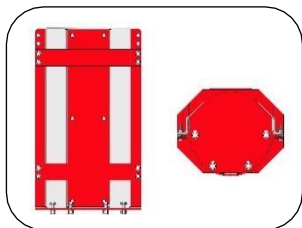

SUPORTE VERTICAL - CILINDRO LS-15 GAL

PN: 11500-0400



ATUADOR PNEUMÁTICO - 2º DISPARO

PN: 11500-0411

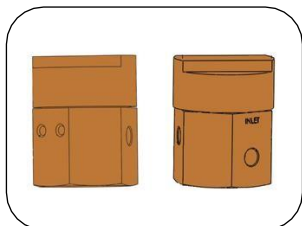

CONTADOR PARA ATUADOR PNEUMÁTICO - 2º DISPARO

PN: 11500-0412

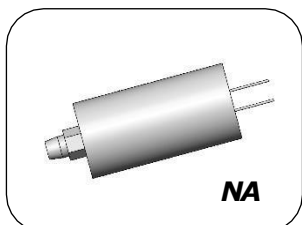

SENSOR DE PRESSÃO "NA" (NORMALMENTE ABERTO)

PN: 11500-0417

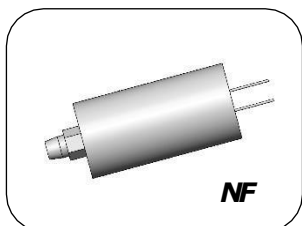

SENSOR DE PRESSÃO "NF" (NORMALMENTE FECHADO)

PN: 11500-0418

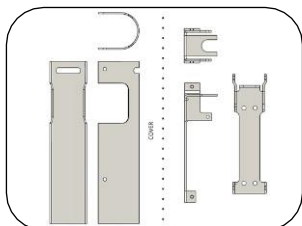

SUPOORTE PARA ATUADOR PNEUMÁTICO - 2º DISPARO

PN: 10005-40

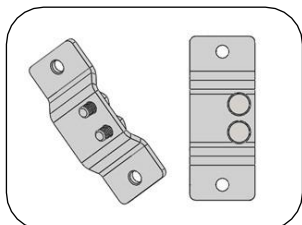

SUPOORTE PARA CONTADOR PARA ATUADOR PNEUMÁTICO - 2º DISPARO

PN: 11500-0414

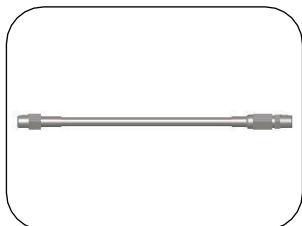

MANGUEIRA FLEXÍVEL EM AÇO INOX 1/8"

PN: 11500-0413

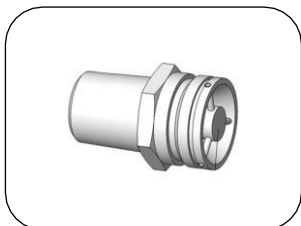

BICO DIFUSOR CÔNICO - DCS

PN: 10224-04



CAPA DE PROTEÇÃO PARA BICO DIFUSOR CÔNICO - DCS

PN: 11500-0471

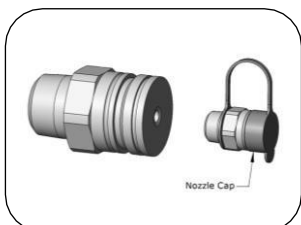

BICO DIFUSOR CÔNICO - LS (PROXIMIDADE ALTA)

PN: 11500-0403

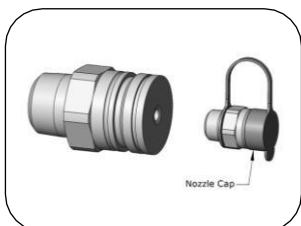

BICO DIFUSOR CÔNICO - LS (PROXIMIDADE BAIXA)

PN: 10005-24

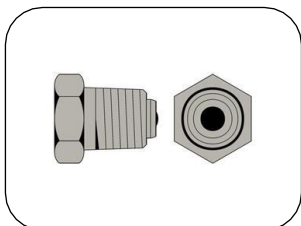

VÁLVULA DE ALÍVIO DE PRESSÃO KVS

PN: 11500-0386

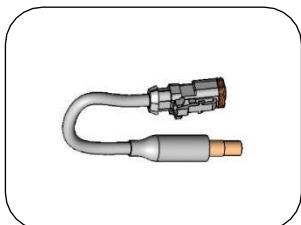

DISPOSITIVO ACIONADOR ELÉTRICO - METRON

PN: 11500-0382

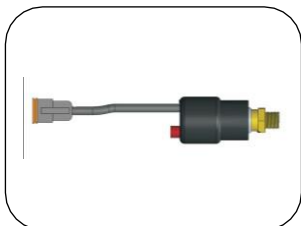

INTERRUPTOR DE PRESSÃO

PN: 10005-42

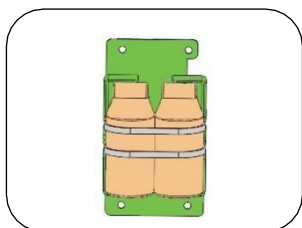

BATERIA DE LITHIUM PARA PAINEL SENTINEL SA1 - 3,6V

PN: 11500-0420

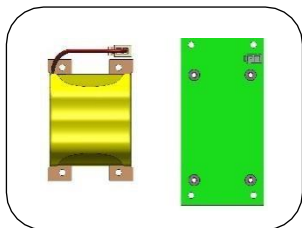

BATERIA RECARREGÁVEL

PN: 11500-0422

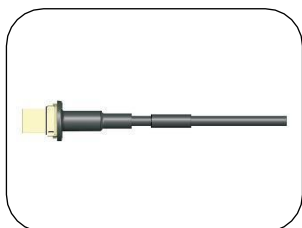

CABO DE ALIMENTAÇÃO SENTINEL NET - 25FT

PN: 10005-63

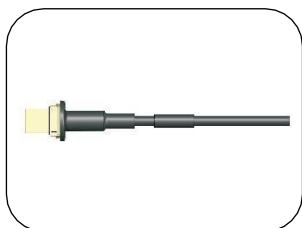

CABO DE ALIMENTAÇÃO SENTINEL NET - 50FT

PN: 10005-64

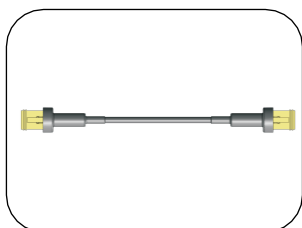

CABO NETWORK SENTINEL NET - 3FT

PN: 10005-66

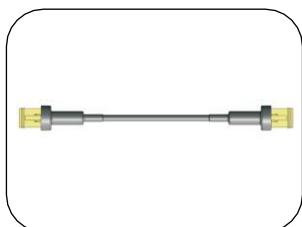

CABO NETWORK SENTINEL NET - 10FT

PN: 10005-68

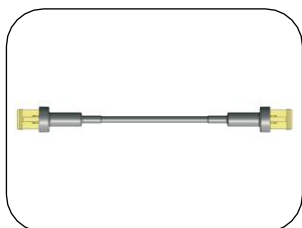

CABO NETWORK SENTINEL NET - 25FT

PN: 10005-69

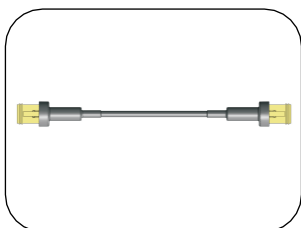

CABO NETWORK SENTINEL NET – 50FT

PN: 10005-70



PAINEL MÓDULO DE CONTROLE NETWORK – SENTINEL NET

PN. 10005-57



PAINEL MÓDULO INTERFACE – SENTINEL NET

PN. 10005-58

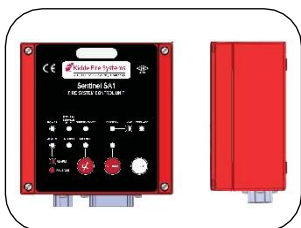

PAINEL DE COMANDO SENTINEL SA1

PN: 11500-0419



PRODUTO SEM IMAGEM
por enquanto

SUPORTE PARA PAINEL KIDDE SA1 +E ATUADOR ELETROME CÂNICO

PN: 11500-0410

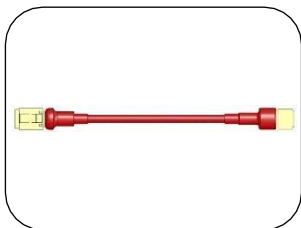

CABO DE DETECÇÃO BASE LHS – 10FT

PN: 11500-0446

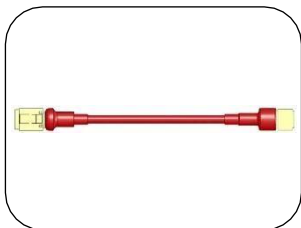

CABO DE DETECÇÃO BASE LHS – 25FT

PN: 11500-0447

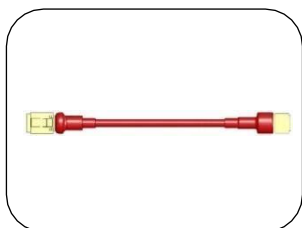

CABO DE DETECÇÃO BASE LHS – 50FT

PN: 11500-0448



CABO DE SUPERVISÃO I/O – 3FT

PN: 10005-78

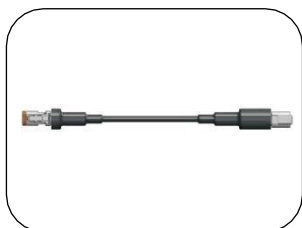

CABO DE SUPERVISÃO I/O – 10FT

PN: 10004-09

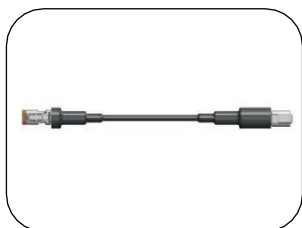

CABO DE SUPERVISÃO I/O – 25FT

PN: 10005-81



CABO DE SUPERVISÃO I/O – 50FT

PN: 10005-82

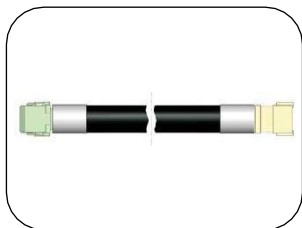

CABO DE DISTRIBUIÇÃO

PN: 10236-14

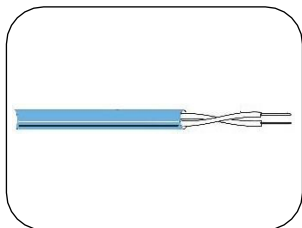

CABO DE DETECÇÃO LINEAR

PN: 10203-10



CAIXA DE DETECÇÃO BASE LHS

PN: 10064-11



ATUADOR MECÂNICO (EXTERNO)

PN: 10064-16

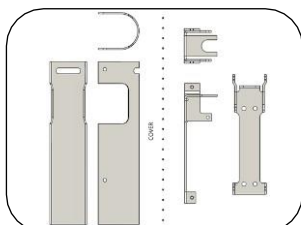

SUPORTE PARA ATUADOR MECÂNICO (EXTERNO)

PN: 10243-17

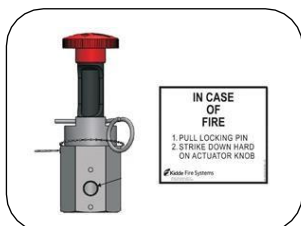

ATUADOR ELETROMECCÂNICO (INTERNO)

PN: 10243-18

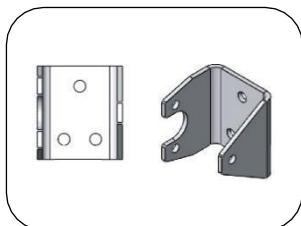

SUPORTE PARA ATUADOR ELETROMECCÂNICO (INTERNO)

PN: 10206-19

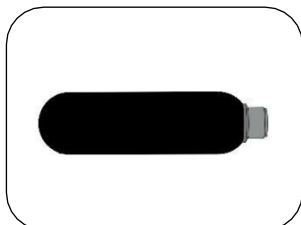

AMPOLA DE NITROGÊNIO N2

PN: 11500-0384

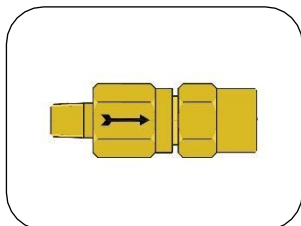

ADAPTADOR COM VÁLVULA DE RETENÇÃO KVS

PN: 11500-0416



SIRENE ÁUDIO VISUAL 24VDC

PN: 11500-0463



ATUADOR MANUAL - BOTOEIRA ELÉTRICA

PN: 11500-0461

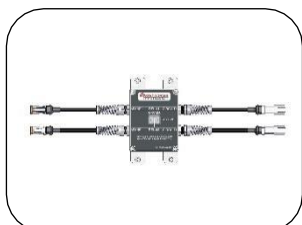

CHAVE BYPASS DE MANUTENÇÃO

PN: 11500-0462

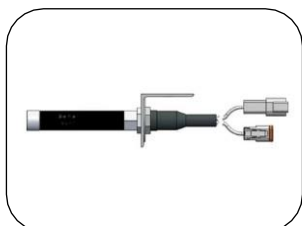

SENSOR DE TEMPERATURA 182°C

PN: 10224-12



DETECTOR ÓPTICO INFRAVERMELHO

PN: 10005-92

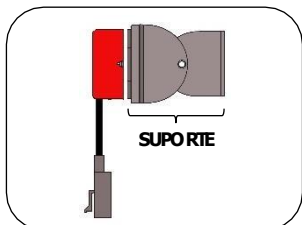

SUPORTE PARA DETECTOR ÓPTICO INFRAVERMELHO

PN: 10005-39

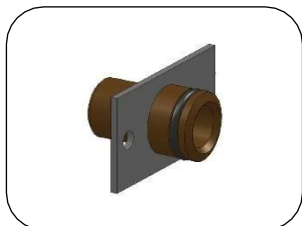

ADAPTADOR DE DESCARGA 3/4" NPT

PN: 11500-0377



5-gallon

REFIL PARA RECARGA AGENTE LÍQUIDO – 5 GALÕES (20 LITROS)

PN: 10400-1727

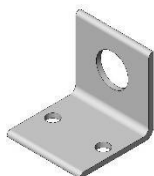

SUPORTE "L" PARA BICO DIFUSOR

PN: 11500-0376

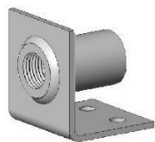

SUPORTE "LUVA" PARA BICO DIFUSOR 1/2" NPT

PN: 11500-0406

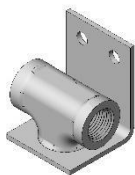

SUPORTE PARA BICO DIFUSOR 1/2" NPT

PN: 11500-0404

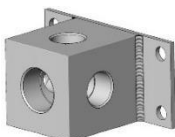

BLOCO DISTRIBUIDOR 4 VIAS – 3/4" x 1/2" x 1/2" x 1/2" x 1/2"

PN: 11500-0378



DISPOSITIVO DE PRESSÃO "NO" (*NORMALMENTE ABERTO) – KIT SHUTDOWN

PN: 11500-0415



PRODUTO SEM IMAGEM
por equívoco

CHAVE GERAL DE ENERGIA DO SISTEMA SENTINEL

PN: 11500-0423



MANGUEIRA HIDRÁULICA ALTA PRESSÃO R01 - 3/4"

PN: 10458-25



MANGUEIRA HIDRÁULICA ALTA PRESSÃO R01 - 1/2"

PN: SUPRH170AX-74



MANGUEIRA HIDRÁULICA ALTA PRESSÃO R01 - 1/4"

PN: 10856-16



TERMINAL REUSÁVEL RETO - 1.1/16" (MANG. 3/4"), AÇO CARBONO

PN: 11500-1579



TERMINAL REUSÁVEL 90° - 1.1/16" (MANG. 3/4"), AÇO CARBONO

PN: 11500-1580



TERMINAL REUSÁVEL RETO - 3/4" (MANG. 1/2"), AÇO CARBONO

PN: 10900-03



TERMINAL REUSÁVEL 90° - 3/4" (MANG. 1/2"), AÇO CARBONO

PN: 10900-04



TERMINAL REUSÁVEL RETO - 1/2" (MANG. 1/4"), AÇO CARBONO

PN: 11500-1581



TÊ MACHO JIC Ø 1.1/16", AÇO CARBONO

PN: 10900-06



ADAPTADOR 90° JIC Ø 7/16"(M) x 1/4" NPT(M), AÇO CARBONO

PN: 10900-07



ADAPTADOR RETO JIC Ø 7/16"(M) x 1/4" NPT(M), AÇO CARBONO

PN: 10900-08



ADAPTADOR RETO JIC Ø 7/16"(M) x 1/8" NPT(M), AÇO CARBONO

PN: 10900-09



ADAPTADOR 90° JIC Ø 7/16"(M) x 1/8" NPT(M), AÇO CARBONO

PN: 10900-10

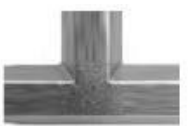

TÊ FÊMEA 1/4" NPT, AÇO CARBONO

PN: 10900-11



ADAPTADOR NIPLE 1/4"(M) x 1/4"(M), AÇO CARBONO

PN: SUPRH170AX-70



ADAPTADOR JIC Ø 1.1/16"(M) x 3/4" NPT(F), AÇO CARBONO

PN: 10900-13



ADAPTADOR 90° JIC Ø 1.1/16"(M) x 3/4" NPT(M), AÇO CARBONO

PN: 11500-1583



ADAPTADOR RETO JIC Ø 3/4"(M) x 1/2" NPT(F), AÇO CARBONO

PN: 10900-15



ADAPTADOR RETO JIC Ø 7/16"(M) x 1/8" NPT(F), AÇO CARBONO

PN: 10900-16



ADAPTADOR 90° JIC Ø 3/4"(M) x 1/2" NPT(M), AÇO CARBONO

PN: 10900-17

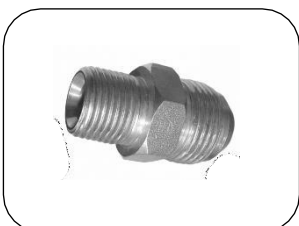

ADAPTADOR RETO JIC Ø 3/4"(M) x 1/2" NPT(M), AÇO CARBONO



ADAPTADOR BUJÃO SEXTAVADO 1/2" NPT(M), AÇO CARBONO

PN: 10900-19



TÊ MACHO JIC Ø3/4" (M), AÇO CARBONO

PN: 10900-20



COTOVELO 90° 1/4" NPT (M) x 1/4" NPT(M), AÇO CARBONO

PN: 10900-21



ADAPTADOR NIPLE DE REDUÇÃO 1/4" NPT(M) x 1/8" NPT(M), AÇO CARBONO

PN: 10900-22



ADAPTADOR LUVA DE REDUÇÃO 1/4" NPT(F) x 1/8" NPT(F), AÇO CARBONO

PN: 10900-23



ADAPTADOR NIPLE 45° 1/2"(M) x 1/2"(M), AÇO CARBONO

PN: 11500-1575



ADAPTADOR NIPLE 1/2"(M) x 1/2"(M), AÇO CARBONO

PN: 11500-1576



ESPIRADUTO DE PROTEÇÃO Ø 3/4" PARA MANGUEIRA Ø 1/4"

PN: 10900-26



ESPIRADUTO DE PROTEÇÃO Ø 1" PARA MANGUEIRAS 1/2" - 3/4"

PN: 10900-27



ABRAÇADEIRA INSJLOCK 4,8MM x 390MM

PN: 10900-28

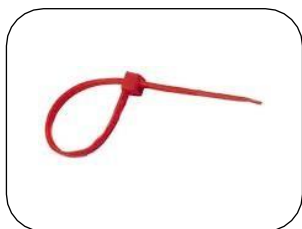

ABRAÇADEIRA INSJLOCK 7,6MM x 390MM

PN: 10900-29



ABRAÇADEIRA DUPLA INSJLOCK 4,8MM x 390MM

PN: 10900-30



PROTEÇÃO PARA CABO LHS - FORNECIMENTO EM METROS

PN: SUPRH170AX-115



PROTEÇÃO PARA CABO LHS - FORNECIMENTO EM PÇ (30CM)

PN: 11500-1578



ABRAÇADEIRA BORRACHA Ø16MM

PN: 10900-30



ABRAÇADEIRA BORRACHA Ø20MM

PN: 10900-32



ABRAÇADEIRA BORRACHA Ø25MM

PN: 10900-33



ARRUELA LISA M8, AÇO CARBONO

PN: 11500-1571



ARRUELA DE PRESSÃO M8, AÇO CARBONO

PN: 11500-1572



PORCA TIPO PARLOCK M8, AÇO CARBONO

PN: 11500-1573



PARAFUSO ALLAEN, M8 X 1 X 1,25mm, AÇO CARBONO

PN: 11500-1574



ANEL DE PROTEÇÃO PARA MANGUEIRA Ø1.3/8"

PN: 11500-1584



ANEL DE PROTEÇÃO PARA MANGUEIRA Ø1.3/4"

PN: 11500-1585

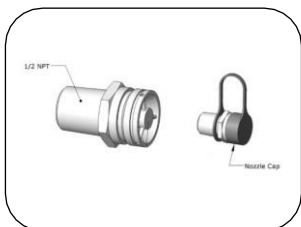

DIFUSOR CÔNICO COM CAPA PARA SISTEMA PQS

PN: 11500-0374

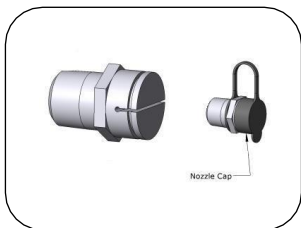

DIFUSOR FAN COM CAPA PARA SISTEMA PQS

PN: 11500-0375



RESISTOR FINAL DE LINHA ATIVAÇÃO 2 PINOS -PRETO

PN: 11500-0385

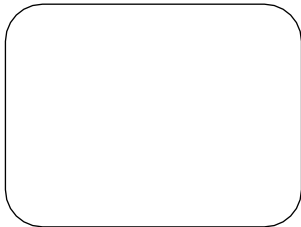

SUPORTE P/ 50 LBS

PN: 11500-0401

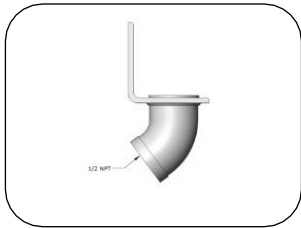

SUPORTE DIFUSOR 45°

PN: 11500-0405



TEE DISTRIBUIÇÃO MANGUEIRAS 3/4

PN: 11500-0407



SUPORTE DO ATUADOR MECÂNICO (REMOTO) SEM PROTEÇÃO

PN: 11500-0408

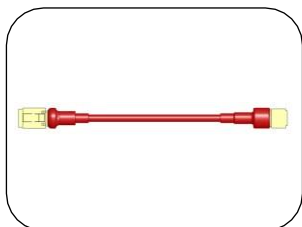

CABO DETECÇÃO 3FT

PN: 11500-0444

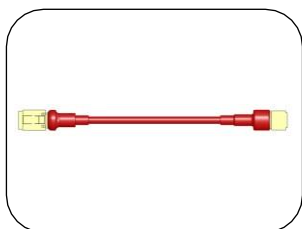

CABO DETECÇÃO 6FT

PN: 11500-0445



CABO TRANSMISSÃO 25FT

PN: 11500-0459



CABO TRANSMISSÃO 50FT

PN: 11500-0460



KIT DE REPARO

PN: 11500-0472



PRODUTO SEM IMAGEM
(por enquanto)

KIT REPARO ATUADOR ELETROMECAÂNICO

PN: 11500-0473



PRODUTO SEM IMAGEM
(por enquanto)

KIT DE REPARO

PN: 11500-0474



PRODUTO SEM IMAGEM
(por enquanto)

KIT DE REPARO

PN: 11500-0475



PRODUTO SEM IMAGEM
(por enquanto)

KIT DE REPARO

PN: 11500-0476



PRODUTO SEM IMAGEM
(por enquanto)

KIT DE REPARO

PN: 11500-0477



PRODUTO SEM IMAGEM
(por enquanto)

BOTÃO DO ATUADOR MECÂNICO

PN: 11500-0478



PRODUTO SEM IMAGEM
(por enquanto)

PINO ATUADOR MECANICO

PN: 11500-0479



PRODUTO SEM IMAGEM
por enquanto

BORRACHA DO ATUADOR MECÂNICO (REMOTO)

PN: 11500-0480



PRODUTO SEM IMAGEM
por enquanto

ADESIVO DO ATUADOR (COMO ATIVAR O SISTEMA)

PN: 11500-0481



PRODUTO SEM IMAGEM
por enquanto

RELESE

PN: 11500-0482



PRODUTO SEM IMAGEM
por enquanto

RELESE

PN: 11500-0483



PRODUTO SEM IMAGEM
por enquanto

RELESE

PN: 11500-0484



PRODUTO SEM IMAGEM
por enquanto

RELESE

PN: 11500-0485



PRODUTO SEM IMAGEM
por enquanto

KIT REPARO ATUADORES ELETROMECÂNICOS

PN: 11500-0486



PRODUTO SEM IMAGEM
(por encomenda)

KIT CONECTOR DEUTSCH 2 PINOS

PN: 11500-0487



PRODUTO SEM IMAGEM
(por encomenda)

KIT CONECTOR DEUTSCH 4 PINOS

PN: 11500-0488



PRODUTO SEM IMAGEM
(por encomenda)

KIT CONECTOR DEUTSCH 6 PINOS

PN: 11500-0489



PRODUTO SEM IMAGEM
(por encomenda)

KIT CONECTOR DEUTSCH PARA PAINEL SA1

PN: 11500-0490



PRODUTO SEM IMAGEM
(por encomenda)

KIT CONECTOR DEUTSCH LINHA DETECÇÃO 3 PINOS

PN: 11500-0491

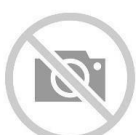

PRODUTO SEM IMAGEM
(por encomenda)

KIT CONECTOR DEUTSCH LINHA DETECÇÃO ADAPTADOR 3 PINOS

PN: 11500-0492



PRODUTO SEM IMAGEM
(por encomenda)

KIT CONECTOR DEUTSCH CABO DE ENERGIA SENTINEL NET/SA1

PN: 11500-0493



PRODUTO SEM IMAGEM
por enquanto

CABO ADAPTADOR PARA SOFTWARE SENTINEL NET

PN: 11500-0494



PRODUTO SEM IMAGEM
por enquanto

CHICOTE PAINEL SENTINEL NET

PN: 11500-0495



RESISTOR FIM DE LINHA DETECÇÃO 3 PINOS -CINZA

PN: 11500-0496



RESISTOR FIM DE LINHA MR/SUP/NOT 2 PINOS -CINZA

PN: 11500-0497



RESISTOR FIM DE LINHA NETWORK 6 PINOS -CINZA

PN: 11500-0498



CHICOTE DETECÇÃO -SENTINEL NET

PN: 11500-0499



CHICOTE RELÊ -SENTINEL NET

PN: 11500-0500



CHICOTE ENERGIA/CONECÇÃO PC -SENTINEL NET

PN: 11500-0501



PRODUTO SEM IMAGEM
por enquanto

VÁLVULA CILINDRO COM PRESSOSTATO PARA CILINDRO KIDDE

PN: 11500-0502



PRODUTO SEM IMAGEM
por enquanto

CONJUNTO DE VÁLVULA PARA CILINDRO KIDDE

PN: 11500-0503



PRODUTO SEM IMAGEM
por enquanto

PRESSOSTATO SUPERVISÃO PARA CILINDRO KIDDE

PN: 11500-0504



PRODUTO SEM IMAGEM
por enquanto

MANÔMETRO PARA CILINDRO KIDDE

PN: 11500-0505



PRODUTO SEM IMAGEM
por enquanto

JUNTA DO ATUADOR

PN: 11500-0506

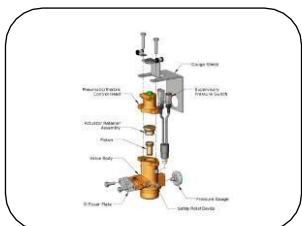

KIT DO CILINDRO

PN: 11500-0507



PRODUTO SEM IMAGEM
(por enquanto)

VALVULA DO CILINDRO LIQUIDO

PN: 11500-0508



PRODUTO SEM IMAGEM
(por enquanto)

VALVULA DO CILINDRO LIQUIDO

PN: 11500-0509



PRODUTO SEM IMAGEM
(por enquanto)

ANEL RING

PN: 11500-0510

GHT

GRUPO HIDRAUTORQUE

REFERÊNCIA NO SEGMENTO DE PEÇAS PARA EQUIPAMENTOS PESADOS



✓ REDUÇÃO DE CUSTOS

✓ AUMENTO DE PRODUTIVIDADE

✓ DISPONIBILIDADE

✓ SEGURANÇA NA OPERAÇÃO

GHT

GRUPO HIDRA TORQUE

Sem Fronteiras para o Amanhã!

ghtsup@grupoht.com.br

+55 (11) 2602 1000