



GHT

REMOVE PIN & LIFT RED BAR

**Escape
Chute**

ESCAPE CHUTE SYSTEM
sales@escape-chute-system

Catálogo
Escape Chute

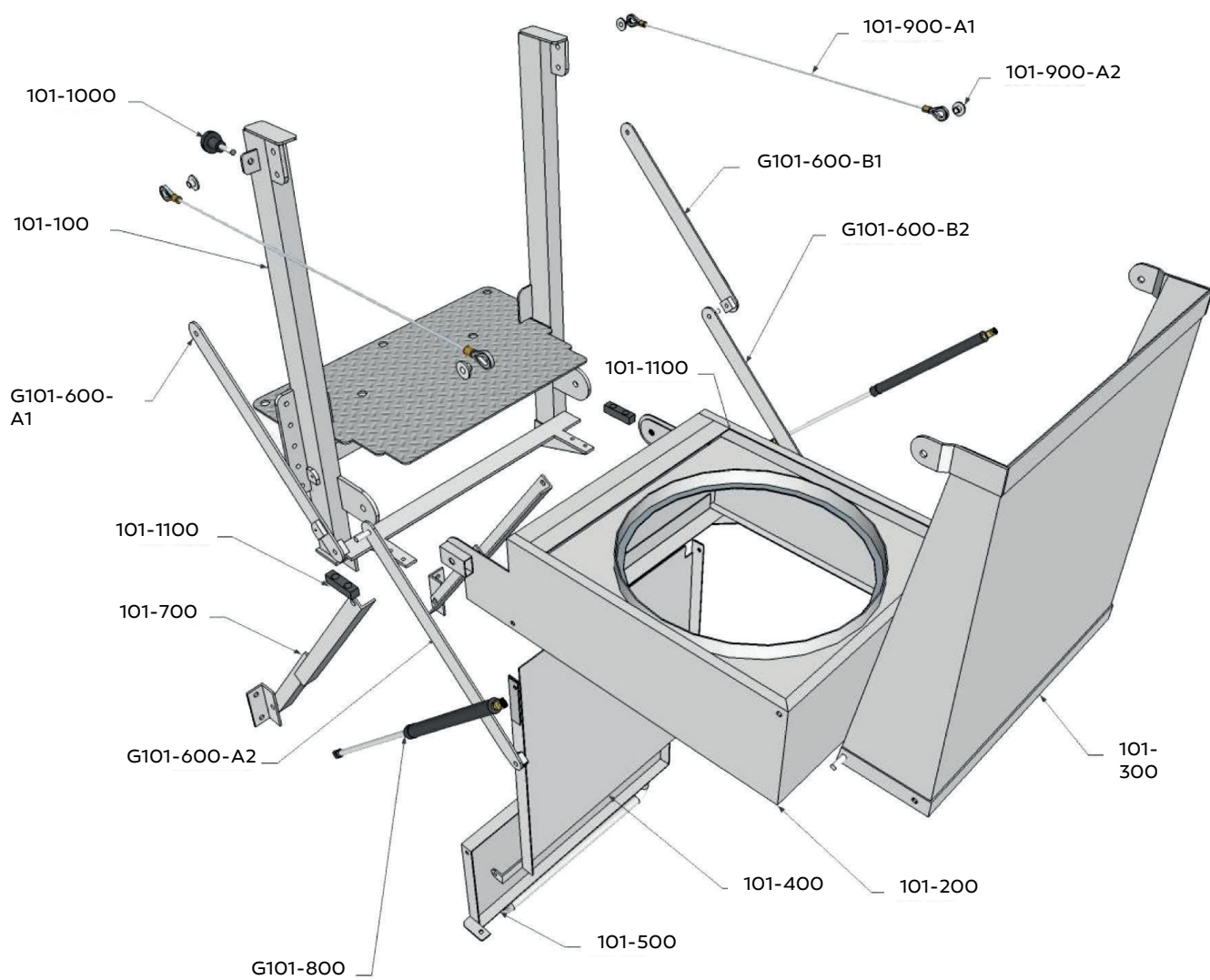



BASE DEMONTAGEM

PN: 101-100

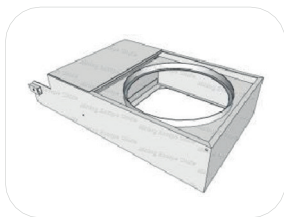

CONTEINER DA RAMPA

PN: 101-200



PLACA DE COBERTURA FRONTAL

PN: 101-300



PLACA DE COBERTURA DA RAMPA

PN: 101-400



CAPA DE LIBERAÇÃO

PN: 101-500

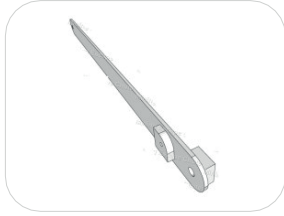

ALAVANCA SUPERIOR DE ACIONAMENTO (LADO DIREITO)

PN: G101-600-A1



ALAVANCA INFERIOR DE ACIONAMENTO (LADO DIREITO)

PN: G101-600-A2



ALAVANCA SUPERIOR DE ACIONAMENTO (LADO ESQUERDO)

PN: G101-600-B1



ALAVANCA INFERIOR DE ACIONAMENTO (LADO ESQUERDO)

PN: G101-600-B2



SUPORTE

PN: 101-700



AMORTECEDOR (CJ-2PCS)

PN: G101-800



CABOS DE GUIA

PN: 101-900-A1

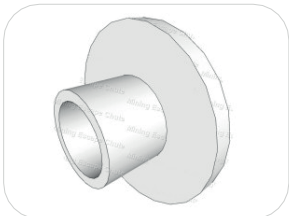

TARUGO DO CABO GUIA

PN: 101-900-A2

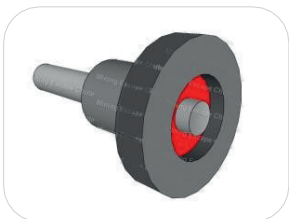

PINO TRAVA

PN: 101-1000



SELO DA RAMPA SUPERIOR/INFERIOR

PN: 101-1100

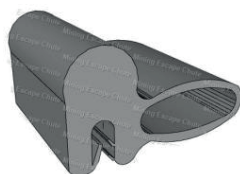

BLOCO DE SUPORTE PARA CONTAINER

PN: 101-1200



ANEL DE RETENÇÃO DA RAMPA

PN: 101-1300

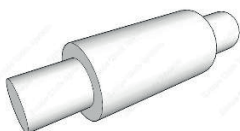

ESPAÇADOR DE ANEL

PN: 101-1400



RAMPA DE FUGA (L: 5000mm)

PN: GSX-5000

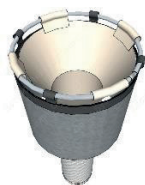

RAMPA DE FUGA (L: 8000mm)

PN: GSX-8000

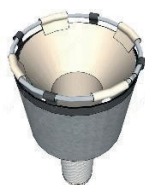

RAMPA DE FUGA (L: 12000mm)

PN: GSX-12000

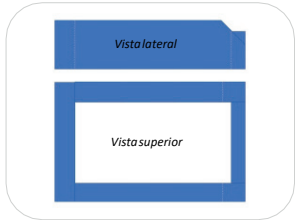

VEDAÇÃO INTERNA ESCAPE CHUTE

PN: VDESCP